



Quick Manual
confocalDT 2421/2422/2465/2466

IFC2421
IFC2422
IFC2465
IFC2466

Contents

General	3
Symbols Used.....	3
Warnings	3
Intended Use.....	4
Proper Environment.....	4
Glossary	4
System Design, Connection Options	5
Sensor Cable, Optical Fiber.....	5
Sensor Mounting, Mounting Adapter	7
Screw Terminals.....	8
RS422 9	
Controller LEDs	9
Multifunction Button.....	10
Start of Measuring Range	10

MICRO-EPSILON
MESSTECHNIK
GmbH & Co. KG
Koenigbacher Str. 15

94496 Ortenburg / Germany

Phone +49 (0) 8542/168-0
Fax +49 (0) 8542/168-90
e-mail info@micro-epsilon.com
www.micro-epsilon.com

Initial Operation	11
Selecting the Sensor.....	11
Performing the Dark Reference	12
Positioning the Target	12
Measurement Configuration Selection	13
Checking the Video Signal	14
Signal Quality	14
Distance Measurement with Website Display	15
One-Sided Thickness Measurement, Transparent Target	17
Preset	17
Material Selection.....	17
Video Signal	18
Measurement Chart	19
RS422 Interface.....	20
Ethernet Interface.....	20
RS422 Data Output, Ethernet	20
IP Address Assignment.....	20
Service, Repair	21
Disclaimer	22
Decommissioning, Disposal	23

You can find more information about the measuring system in the operating instructions. They are available online at:

www.micro-epsilon.com/download/manuals/man--confocalDT-2421-2422-2465-2466--en.pdf



General

Symbols Used

The following symbols are used in this document:



Indicates a hazardous situation which, if not avoided, may result in minor or moderate injury.



Indicates a situation that may result in property damage if not avoided.



Indicates a user action.



Indicates a tip for users.

Warnings



Connect the power supply and the display/output device according to the safety regulations for electrical equipment.

> Risk of injury, damage to or destruction of the sensor and/or the controller



Avoid shocks and impacts to the sensor and controller.

> Damage to or destruction of the sensor and/or the controller

The supply voltage must not exceed the specified limits.

> Damage to or destruction of the sensor and/or the controller

Never kink optical fibers or bend them in tight radii.

> Damage to or destruction of the optical fiber, failure of measuring device

Protect the ends of the optical fiber against contamination (use protective caps).

> Incorrect measurement, failure of the measuring device

Protect the cable against damage.

> Failure of the measuring device

Intended Use

- The measuring system is designed for use in an industrial environment. It is used for
 - displacement, distance and movement measurement, thickness measurement,
 - measuring the position of parts or machine components
- The measuring system must only be operated within the limits specified in the technical data.
- ➡ The measuring system must only be used in such a way that no persons are endangered or machines are damaged in the event of malfunction or total failure of the sensor.
- ➡ Take additional precautions for safety and damage prevention in case of safety-related applications.

Proper Environment

- Sensor protection class: IP40 ... IP65
- Controller protection class: IP40

Lenses are excluded from protection class. Contamination of the lenses causes impairment or failure of the function.

- Operating temperature range
 - Sensor: +5 ... +70 °C (+41 ... +158 °F)
 - Controller: +5 ... +50 °C (+41 ... +122 °F)
- Storage temperature range: -20 ... +70 °C (-4 ... +158 °F)
- Humidity: 5 ... 95 % (non-condensing)
- Ambient pressure: Atmospheric pressure
- EMC: As per EN 61000-6-3 / EN 61326-1 (Class B) Emitted interference; EN 61000-6-2 / EN 61326-1 Immunity to interference

Glossary

SMR Start of measuring range

MMR Mid of measuring range

MR Measuring range

EMR End of measuring range

Minimum target thickness See Sensor Technical Data, Operating Instructions

Maximum target thickness Sensor measuring range x Refractive index of target

System Design, Connection Options

► Connect the components to one another, install the sensors in the holders.

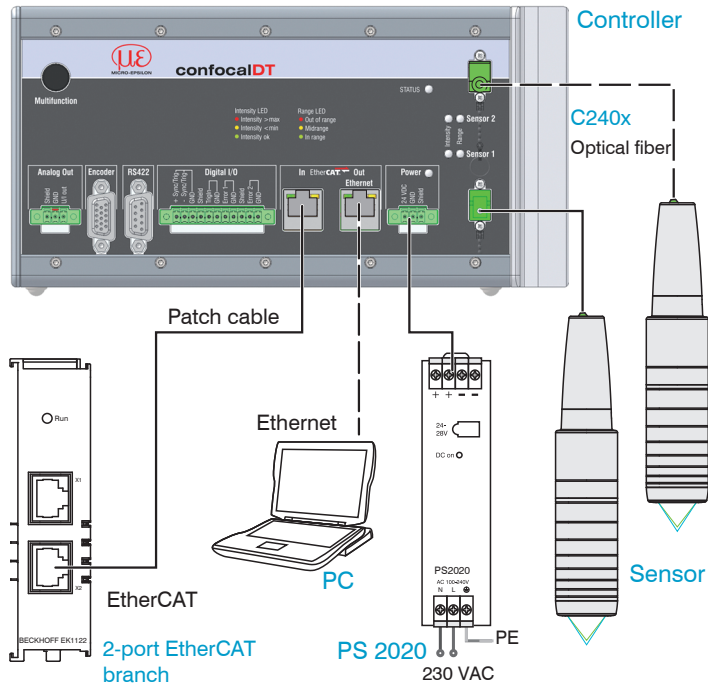

Sensor Cable, Optical Fiber

The sensor is connected to the controller by means of an optical fiber.

- Do not shorten or extend the optical fiber.
- Do not pull or carry the sensor by the cable.

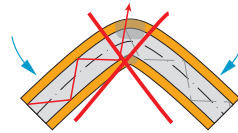

Do not kink the sensor cable.

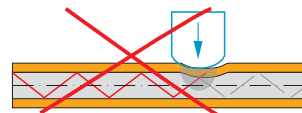

Do not squash the sensor cable, do not use cable ties to secure it.

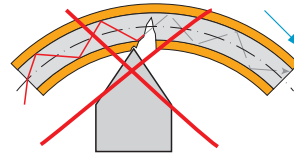

Do not pull the sensor cable over sharp edges.

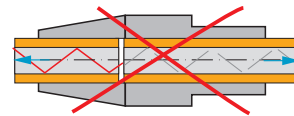

Do not pull on the sensor cable.

The plugs may only be cleaned by persons with the appropriate expertise.

General Rules

Do not

- any contamination of the connector, e.g., dust
- apply any mechanical stress to the optical fiber
- curve the cable to a significant extent

Never bend the sensor cable more tightly than the permitted bending radius.

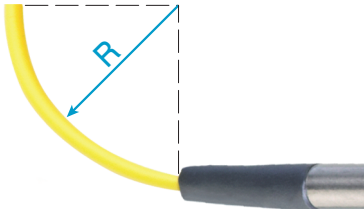

If the cable is immovably routed:

$R = 30$ mm or more

If the cable is movably routed:

$R = 40$ mm or more



IFS2405 series sensor clamped in an MA2405-x mounting adapter

Sensor Mounting, Mounting Adapter

IFS240x optical sensors operate in the μm range.

- Ensure careful handling during installation and operation!

➡ Install the IFS240x sensors using a mounting adapter or on the mounting surface/mounting thread.

Sensor Mounting adapter	IFS2402-x	IFS2403-x	IFS2404-2 IFS2404-2(001) IFS2404/90-2 IFS2404/90-2(001)	IFS2405-0,3 IFS2405-1	IFS2405-3	IFS2405-6 IFS2405/90-6	IFS2405-10	IFS2405-28 IFS2405-30	IFS2406-2,5 IFC2406-2,5/VAC(003) IFS2406/90-2,5/VAC(001)	IFS2406-3 IFS2406-3/VAC(001) IFS2406-10	IFS2407-0,1 IFS2407-0,8	IFS2407-3	ISF2407/90-0,3
MA2400-27				•						•			
MA2402-4	•												
MA2403-8		•											
MA2404-12			•								•		
MA2405-34					•								
MA2405-40						•							
MA2405-54							•					•	
MA2405-62								•					
MA2406-20									•				
Mounting thread													•

The adjustable JMA-xx mounting adapter is compatible with numerous confocalDT sensor models. For more information on this accessory, see the operating instructions.

Screw Terminals

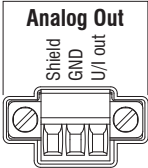
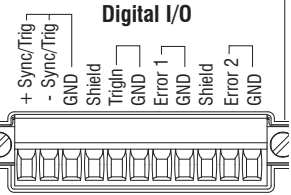
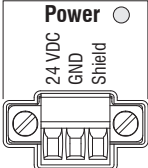
Pin	Description	Notes	
U/I out	Voltage output	0 ... 5 V; 0 ... 10 V; R_i approx. 50 Ohm; 5.5 V / 10.9 V in the event of an error, outside of measuring range	
	Current output	4 ... 20 mA; $R_L \leq 500$ Ohm; 23.7 mA in the event of an error, outside of measuring range	
GND	Ground analog output	Electrically connected to supply	
+Sync/Trig -Sync/Trig	Input/output synchronization, input triggering	RS422 level (EIA422)	
TrigIn	Input triggering	TTL or HTL level TTL: Low ≤ 0.8 V, High ≥ 2 V HTL: Low ≤ 3 V, High ≥ 8 V	
Error 1 / 2	Error outputs	NPN, PNP or Push-Pull $I_{max} = 100$ mA, $U_{H,max} = 30$ V	
GND	Reference ground	All GND conductors are interconnected with one another and to operating voltage ground.	
24 VDC	Operating voltage	$\pm 15\%$, $I_{max} < 1$ A	
GND	Operating voltage ground	GND is electrically connected to GND of switching outputs, synchronization, analog and encoder input	
Shield	Shields for relevant output/input, plug housing		

The plug-in screw terminals are designed for an optical fiber cross-section of 0.14 mm² to 1.5 mm².

To comply with IEC 61326-1:2020/CISPR 16-2-3, a split ferrite with an impedance of at least 140 ohms at 100 MHz with 2 turns must be attached to the analog output cable. MICRO-EPSILON recommends the split ferrite from Würth, article number 74271622.

RS422

- Differential signals according to EIA-422, electrically isolated from the supply voltage.
- Receiver Rx with 120 Ohm internal terminating resistor.

➡ Terminate the transmitter input Tx on the evaluation unit (receiver) with 90 ... 120 Ohm.

➡ Use a shielded cable with twisted wires.
Cable length less than 30 m.

➡ Connect the ground connections.

i The pin assignment for the 9-pin D-sub socket is not standardized.

Pin	Name	Signal
3	RX -	Receiver -
2	RX +	Receiver +
5	GND422	Ground RS422
9	TX +	Transmitter +
1	TX -	Transmitter -
Housing	Shield	Cable shield

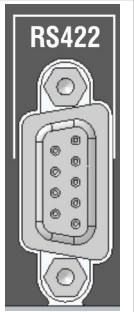

Pin assignment for 9-pin D-Sub socket (RS422)

Controller LEDs

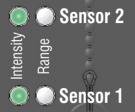
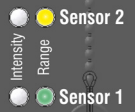
Power on	Green	Operating voltage present	
Status	Off	No error	
	Flashing red	Error during processing	
	If the EtherCAT interface is active, refer to the EtherCAT guidelines for the meaning of the LEDs.		
Intensity Sensor 1/2		Flashing red	Dark signal acquisition in progress
		Red	Signal saturated
		Yellow	Signal too low
		Green	Signal OK
Range Sensor 1/2		Flashing red	Dark signal acquisition in progress
		Red	No target present, outside of measuring range
		Yellow	Target close to mid of measuring range
		Green	Target within the measuring range

Multifunction Button

The Multifunction button on the controller is assigned multiple functions. As standard, the button is assigned the dark reference function.

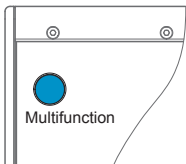

Function 1	Dark reference	<i>Starts the dark reference for sensor 1 or sensor 2</i>
Function 2	Mastering, Reset Mastering	<i>Starts or stops a master measurement of the selected signals</i>
	LED	<i>Switches the light source for sensor 1 or sensor 2 on/off</i>

The functions can be assigned to the individual time slots. All time intervals are indicated by the LEDs flashing/lighting up.

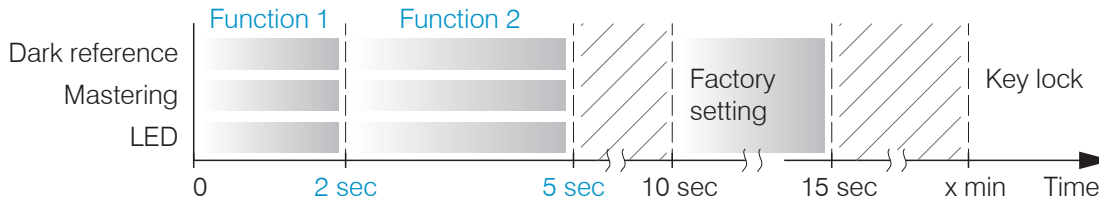

Multifunction Button Actuation Time

As standard, the Multifunction button has a lock that is activated 5 min after the controller is started.

Start of Measuring Range

An offset distance (SMR) between each sensor and the target must be kept.

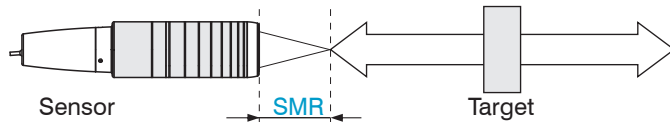

Start of measuring range (SMR), the shortest distance between the front surface of the sensor and the target.

Initial Operation

The measuring system is ready to use approx. 10 s after applying the supply voltage.

To ensure precise measurements, let the measuring system warm up for approx. 30 minutes.

The controller is shipped with the factory-set IP address 169.254.168.150.

You can query the IP addresses of the controllers that are connected to a PC or network by using the `sensorTOOL.exe` program. You can find this program online at <https://www.micro-epsilon.com/download/software/sensorTOOL.exe>.

➤ Launch the `sensorTOOL` and click the  button.

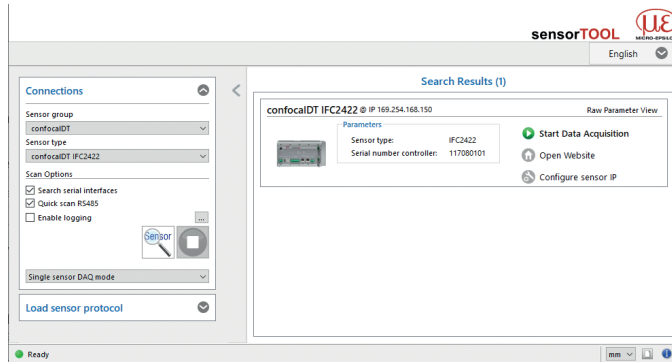

➤ Select the controller from the list.

confocalDT 2421/2422/2465/2466

➤ Click the `Open Website` button to connect the controller to your default browser.

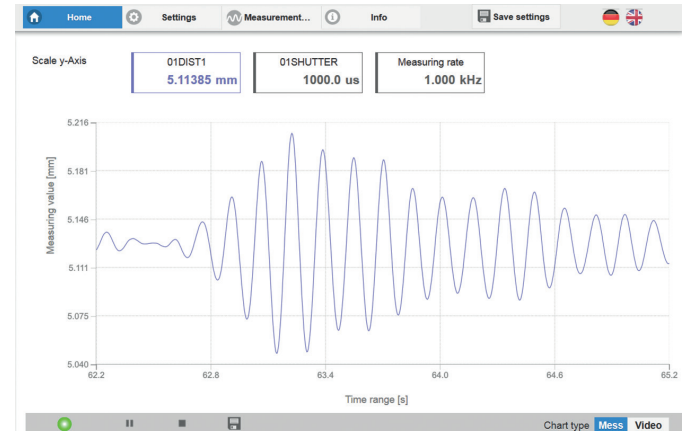

The start screen of the controller software should now be displayed in the web browser. You can configure the software using the web pages or ASCII commands integrated in the controller.

Selecting the Sensor

➤ Go to the `Settings > Sensor` menu.

➤ Select the connected sensor for the relevant channel. Pay attention to type and serial number.

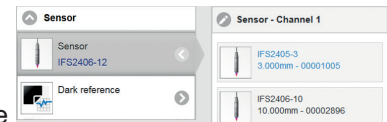

Performing the Dark Reference

This step is required each time a sensor is changed; controller warm-up time approx. 30 min.

- Cover the sensor with a piece of dark paper. Go to the Settings > Sensor > Dark reference menu and click on the Start button.
- As a check, set the measuring rate to 100 Hz, Settings > Data recording > Measuring rate menu.
- Use Video to select the video signal display.

Make sure that an exposure time of $10,000 \mu\text{s}$ is displayed. If the signal is not satisfactory, we recommend cleaning the connections on the controller and on the fiber optics. For this, use the One-Click Cleaner from the optional accessories, article 0135032.



Typical signal curve for a dark signal

During the dark reference, there must be no objects within the measuring range nor ambient light reaching the sensor under any circumstances. Duration approx. 50 s.

Positioning the Target

- Position the target as centrally as possible within the measuring range.

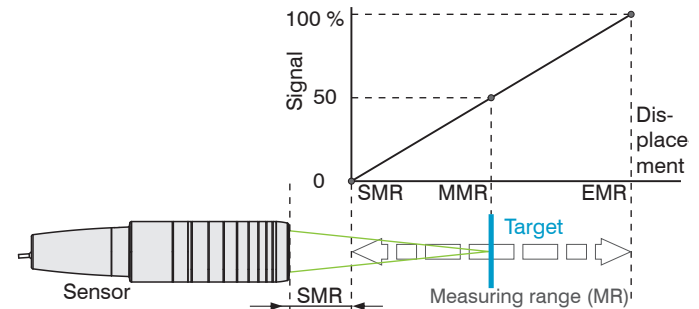

The Range LED on the front of the controller indicates the position of the target relative to the sensor.

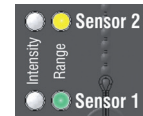

Flashing red	Dark signal acquisition in progress
Red	No target present or target outside of measuring range
Yellow	Target close to mid of measuring range
Green	Target within the measuring range

Measurement Configuration Selection

Conventional measurement configurations (presets) for various target surfaces are saved in the controller.

Basic features such as the peak and material selection and the calculation functions are already set in the Presets.

➡ Go to the Home > Measurement configuration menu and start the Stored configurations. Select a configuration or setup.

Then, you can apply your own settings (setups). When saving a modified preset, the web interface displays a dialog for entering a setup name.

Presets:

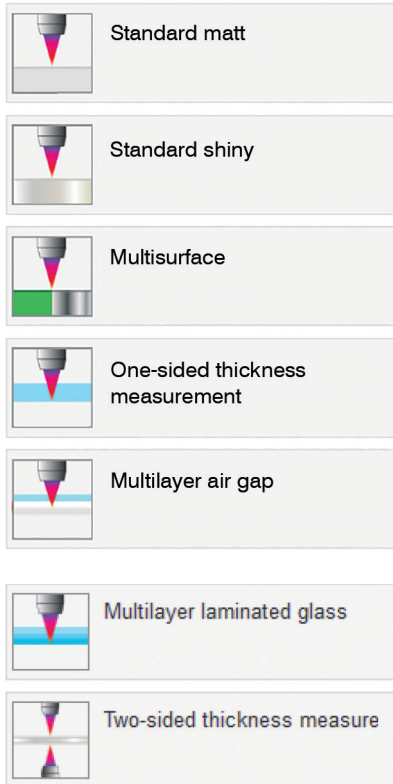

Distance measurement, e.g., for ceramic material, non-transparent plastics. Highest peak, no averaging, distance calculation.

Distance measurement, e.g., for metal, polished surfaces. Highest peak, median over 5 values, distance calculation.

Distance measurement, e.g., for PCBs, hybrid materials. Highest peak, median over 9 values, distance calculation.

One-sided thickness measurement, e.g., for glass, BK7 material. First and second peak, no averaging, thickness calculation.

Layer thickness measurement¹ for laminated glass, e.g. windshield, 1st layer BK7, 2nd layer PC, 3rd layer BK7, first and second peak, no averaging.

Thickness measurement¹ e.g. for mask under glass. 1st layer BK7, 2nd layer air, first and second peak, median over 5 values.

Two-sided thickness measurement² for metal. Highest peak, median over 5 values.
Formula: $-1*01DIST -1*02DIST1 + 10$

1) Possible in the IFC242x (001) MP and IFC2465/66 (001) MP controllers.

2) Possible in the IFC2422 and IFC2466 controllers.

Checking the Video Signal

- ➔ Go to the Measurement chart menu. Overlay the video signal display using Video. In the Signal selection section, you can switch between channel 1 (sensor 1) and channel 2 (sensor 2). If required, make adjustments to the exposure mode and measuring rate.

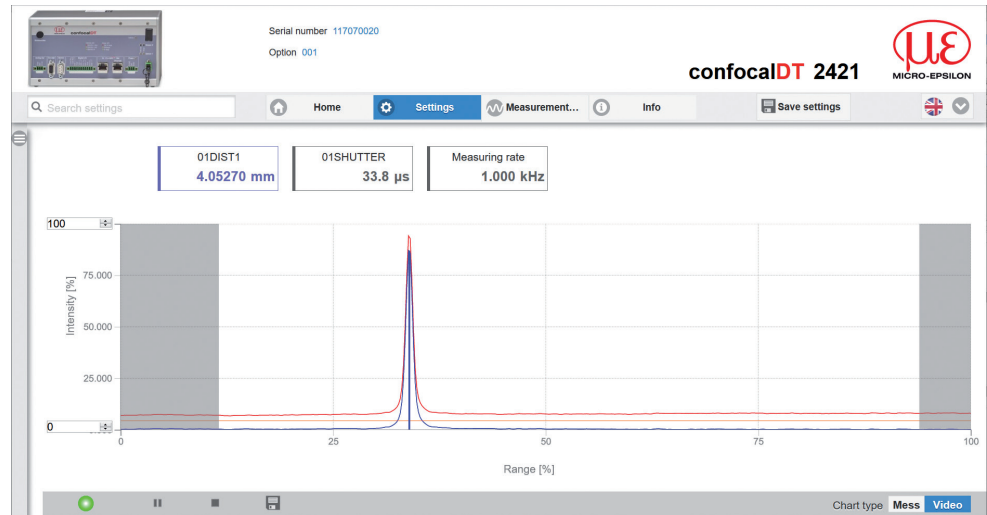

Signal Quality

A good measurement result can be achieved if the video signal is sufficiently intense. Reducing the measuring rate increases the exposure time for the CCD row and thus improves the measurement quality.

- ➔ Go to the Home > Signal quality menu and adjust the measurement dynamics as required. Monitor the result in the video signal.

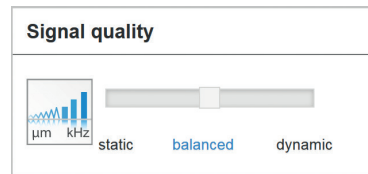

	Measuring rate	Averaging
Static	200 Hz	Moving, 128 values
Balanced	1 kHz	Moving, 16 values
Dynamic	6.5 kHz	Moving, 4 values

Distance Measurement with Website Display

➤ Align the sensor perpendicularly to the object to be measured.

➤ Then, move the sensor (or the target) closer and closer to the start of the measuring range of the relevant sensor.

As soon as the object is within the measuring field of the sensor, the Range LED on the front panel of the controller lights up (green or yellow). Alternatively, you can watch the video signal.

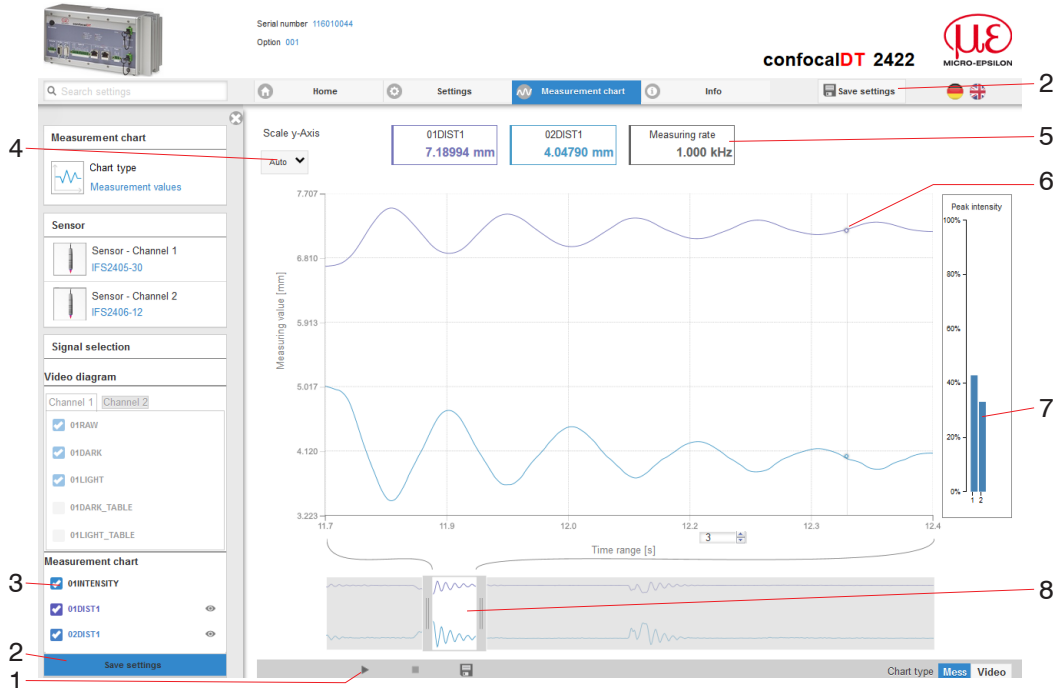

Measurement (*distance measurement*) web page

- 1 `Stop` pauses the chart; you can still use the data selection and zoom functions. `Save` opens a Windows selection dialog for the file name and save location to save the last 10,000 values in a CSV file (separation using semicolon).
- 2 All changes only become effective when you click on the `Save settings` button.
- 3 In the left-hand window, the signals of channel 1/2 to be displayed can be switched on or off during or after the measurement. Inactive curves are grayed out and can be added by clicking on the check mark. The changes become effective when you save the settings.
You can show or hide the individual signals using the eye symbols . The calculation continues in the background.
 - 0xSHUTTER: Exposure time
 - 0xINTENSITY: Signal quality of the underlying peak in the video signal
 - 0xDIST: Distance signal curve over time
- 4 To scale the axis in the graph for the measured values (Y axis), you can use `Auto` (= automatic scaling) or `Manual` (= manual scaling).
- 5 The current values for distance, exposure time, current measuring rate and time stamp are shown in the text boxes above the graph. Errors are also displayed.
- 6 Mouseover function. When the chart has been stopped and you move the mouse over the graph, points on the curve are marked with a circle and the associated values are displayed in the text boxes above the graph. The intensity bars are also updated.
- 7 The peak intensity is displayed as a bar chart.
- 8 Scaling the x axis: During an ongoing measurement, you can use the left-hand slider to enlarge the entire signal (zoom). The time range can also be defined using an input field under the time axis. When the chart has been stopped, the right-hand slider can also be used. You can also move the zoom window with the mouse in the center of the zoom window (four-sided arrow).

One-Sided Thickness Measurement, Transparent Target

The controller evaluates two signals reflected on the surfaces. Based on these two signals, the controller calculates the distances from the surfaces and, from this, derives the thickness.

➤ Align the sensor perpendicularly to the object to be measured. Make sure that the target is approximately in the mid of the measuring range ($SMR + 0.5 \times MR$).

i The light beam must strike the surface of the object at a perpendicular angle. Otherwise, measurements might be inaccurate.

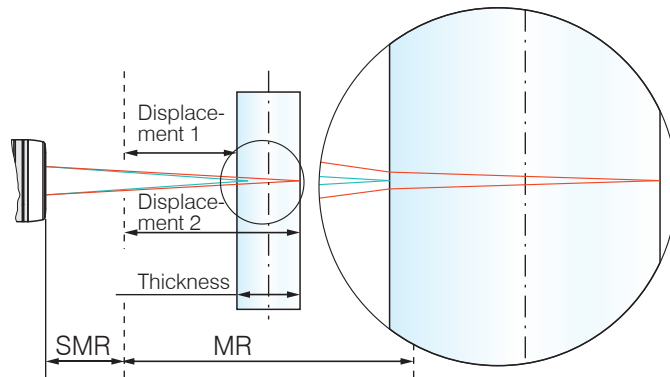

One-sided thickness measurement for a transparent target

Preset

➤ Switch to the Home menu.

➤ Select One-sided thickness measurement in the Measurement configuration menu.

This presetting prompts the controller to use the first and second peak in the video signal for the thickness calculation.

Material Selection

Specifying the material is essential for calculating a correct thickness value. To compensate for the spectral change of the index of refraction, at least three refractive indices at different wavelengths or a refractive index and the Abbe number must be known.

➤ Switch to the Settings > Data recording > Material selection menu.

➤ Select the material of the target for Layer 1.

Video Signal

If a surface of the target lies outside the measuring range, the controller will send only one signal for the distance, intensity and center of gravity. This may also occur if a signal is below the detection threshold. Two boundary surfaces are active when the thickness of a transparent material is measured. As a result, two peaks are visible in the video signal.

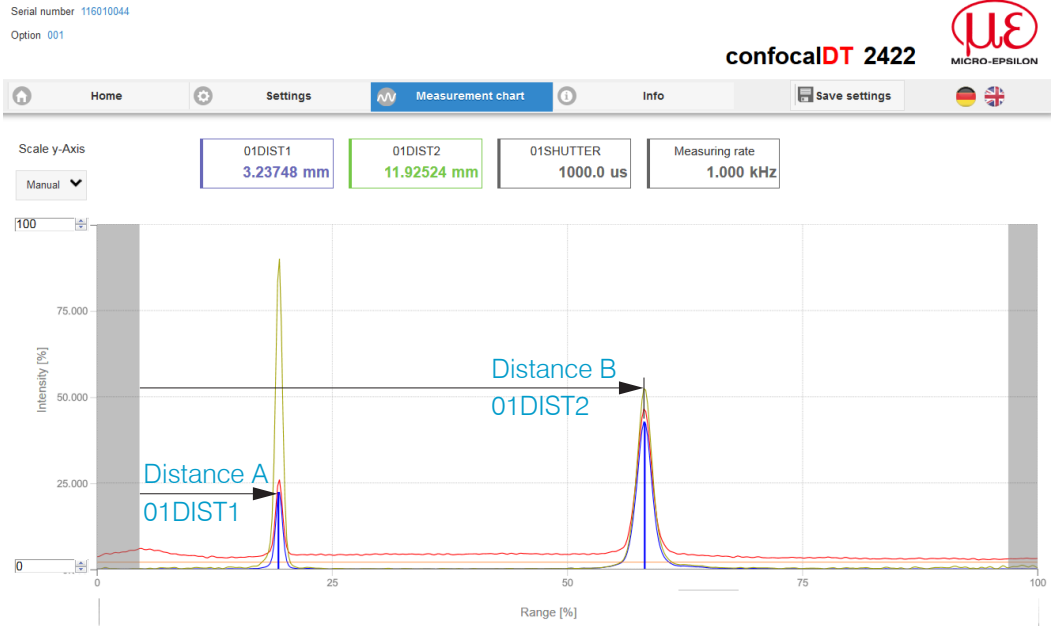

Video signal (*thickness measurement*) web page

Measurement Chart

➤ Switch to the **Measurement chart** tab and select **Mess** as the chart type.

The web page shows the two distances and the thickness **Ch01Thick12** (difference between **01DIST2** and **01DIST1**) graphically and numerically. Optionally, the intensities of both peaks (**Peak 1 = near, Peak 2 = far**) can also be displayed.

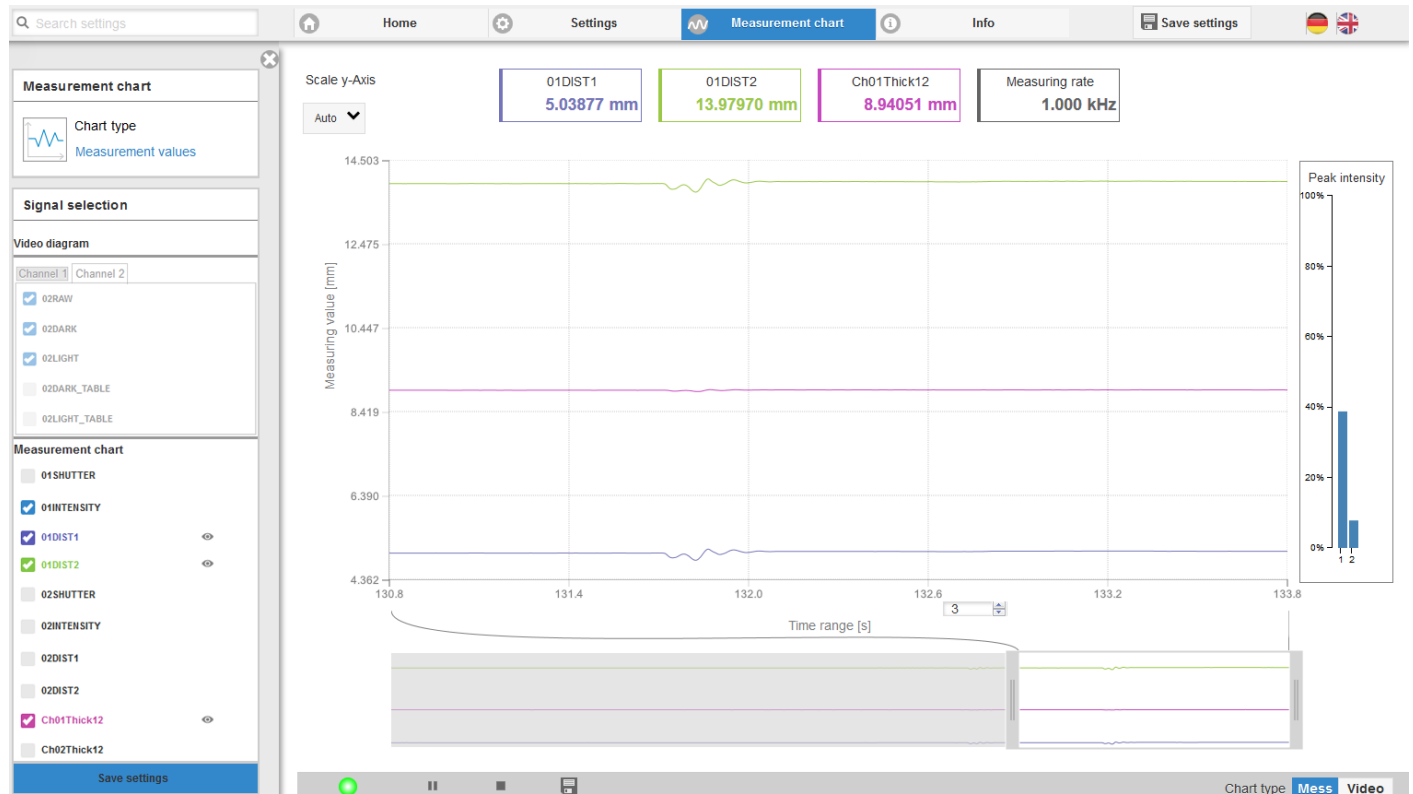

RS422 Interface

The RS422 interface has a maximum baud rate of 4000 kBaud. The baud rate is set to 115.2 kBaud when the interface is delivered.

The RS422 interface transmits 18 bits per output value. The maximum number of measured values that can be transmitted for a measuring point depends on the measuring rate of the controller and the transmission rate set for the RS422 interface.

Ethernet Interface

The controller transmits the TCP/IP packets at an Ethernet transmission rate of 10 MBit/s or 100 MBit/s.

When measurement value data are transmitted to a measurement value server, the controller sends each measured value to this server or to the connected client after the connection has been successfully set up. No specific request is required for this.

The distance and thickness values are transmitted as a 32-bit signed integer with a resolution of 1 nm.

RS422 Data Output, Ethernet

The selection of output data from all internally determined values and from the calculated values from the computing modules is done separately for both interfaces. These data are output in a rigidly defined order. The selection for Ethernet includes the signals for the measured value transfer as well as video data, but not the online chart.

Selecting the output data

IP Address Assignment

- Switch to the `Settings > Outputs > Ethernet settings` menu.
 1. First, change the gateway setting.
 2. Then, enter a new IP address.
- Launch the web interface with the new IP address.
- Save the new device settings. To do this, use the `Save settings` button.

Service, Repair

If the sensor, controller or sensor cable is defective:

- If possible, save the current sensor settings in a parameter set to reload them into the controller after the repair.
- Please send us the affected parts for repair or exchange.

If the cause of a fault cannot be clearly identified, please send the entire measuring system to:

MICRO-EPSILON MESSTECHNIK

GmbH & Co. KG

Koenigbacher Str. 15

94496 Ortenburg / Germany

Tel. +49 (0) 8542 / 168-0

Fax +49 (0) 8542 / 168-90

info@micro-epsilon.com

www.micro-epsilon.com

Disclaimer

All components of the device have been checked and tested for functionality in the factory. However, should any defects occur despite careful quality control, these shall be reported immediately to MICRO-EPSILON or to your distributor / retailer.

MICRO-EPSILON undertakes no liability whatsoever for damage, loss or costs caused by or related in any way to the product, in particular consequential damage, e.g., due to

- non-observance of these instructions/this manual,
- improper use or improper handling (in particular due to improper installation, commissioning, operation and maintenance) of the product,
- repairs or modifications by third parties,
- the use of force or other handling by unqualified persons.

This limitation of liability also applies to defects resulting from normal wear and tear (e.g., to wearing parts) and in the event of non-compliance with the specified maintenance intervals (if applicable).

MICRO-EPSILON is exclusively responsible for repairs. It is not permitted to make unauthorized structural and / or technical modifications or alterations to the product. In the interest of further development, MICRO-EPSILON reserves the right to modify the design.

In addition, the General Terms of Business of MICRO-EPSILON shall apply, which can be accessed under Legal details | Micro-Epsilon <https://www.micro-epsilon.com/impressum/>.

For translations into other languages, the German version shall prevail.

Decommissioning, Disposal

In order to avoid the release of environmentally harmful substances and to ensure the reuse of valuable raw materials, we draw your attention to the following regulations and obligations:

- Remove all cables from the sensor and/or controller.
- Dispose of the sensor and/or the controller, its components and accessories, as well as the packaging materials in compliance with the applicable country-specific waste treatment and disposal regulations of the region of use.
- You are obliged to comply with all relevant national laws and regulations.

For Germany / the EU, the following (disposal) instructions apply in particular:

- Waste equipment marked with a crossed garbage can must not be disposed of with normal industrial waste (e.g. residual waste can or the yellow recycling bin) and must be disposed of separately. This avoids hazards to the environment due to incorrect disposal and ensures proper recycling of the old appliances.
- A list of national laws and contacts in the EU member states can be found at https://ec.europa.eu/environment/topics/waste-and-recycling/waste-electrical-and-electronic-equipment-weee_en. Here you can inform yourself about the respective national collection and return points.
- Old devices can also be returned for disposal to MICRO-EPSILON at the address given in the imprint at <https://www.micro-epsilon.com/impressum/>.
- We would like to point out that you are responsible for deleting the measurement-specific and personal data on the old devices to be disposed of.
- Under the registration number WEEE-Reg.-Nr. DE28605721, we are registered at the foundation Elektro-Altgeräte Register, Nordostpark 72, 90411 Nuremberg, as a manufacturer of electrical and/or electronic equipment.

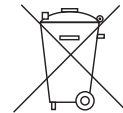



MICRO-EPSILON MESSTECHNIK GmbH & Co. KG

Koenigbacher Str. 15 · 94496 Ortenburg / Germany

Tel. +49 (0) 8542/168-0 · Fax +49 (0) 8542/168-90

info@micro-epsilon.com · www.micro-epsilon.com

Your local contact: www.micro-epsilon.com/contact/worldwide/

X9691367.01-A012052DTa

© MICRO-EPSILON MESSTECHNIK